

Civil War Part 2

1863-1865

Gettysburg Casualties

	Union Army	Confederate Army
Commanders	George E. Meade	Robert E. Lee
Troop strength	75,000	50,000
Losses		
Killed	3,155	3,903
Wounded	14,529	18,735
Captured, missing	5,365	5,425
Total Losses	23,049	28,063

Source: Data from Battles and Leaders of the Civil War (1884–1888; reprinted ed., 1956).

Extensive Legislation Passed by Congress

- 1862 - Homestead Act
- 1862 - Legal Tender Act
- 1862 - Morrill Land Grant Act
- 1863 - Pacific Railway Act
- 1863 - National Bank Act

THE DRAFT.

The draft will commence in the 14th Congressional District, on

Thursday, Sept. 17th, 1863,

At 10 o'clock A. M., at the Court House in
Wooster, Ohio.

The whole number required from this district is **SIX HUNDRED AND NINETEEN**, to which fifty per cent will be added to cover exemptions. The following table exhibits the number to be drafted from each sub-district:

HOLMES COUNTY—To the first sub-district, **21**; Second, **21**; Third, **18**; Fourth, **27**; Fifth, **12**; Sixth, **18**; Seventh, **19**.

ASHLAND COUNTY—Eighth sub-dist., **24**; Ninth, **20**; Tenth, **24**; Eleventh, **27**; Twelfth, **21**; Thirteenth, **18**; Fourteenth, **24**.

WYNE COUNTY—Fifteenth sub-district, **30**; Sixteenth, **25**; Seventeenth, **24**; Eighteenth, **29**; Nineteenth, **30**; Twentieth, **23**; Twenty-first, **41**; Twenty-second, **24**.

MEDINA COUNTY—Twenty-third sub-district, **30**; twenty-fourth, **19**; twenty-fifth, **27**; twenty-sixth, **17**; twenty-seventh, **10**; twenty-eighth, **14**; twenty-ninth, **12**; thirtieth, **15**; thirty-first, **15**.

LORAIN COUNTY—32d sub-district: 16: 33d, 24; 34th, 13; 35th, 15; 36th, 29; 37th, 24; 38th, 26; 39th, 15; 40th, 22; 41st, 20; 42d, 15.

The draft will commence with the forty-second sub-district in Lorain county, and end with the first sub-district in Holmes county.

JAMES L. DRAKE,

Wooster, Sept. 11, 1863.

Capt. & Provost Marshal.

*The North Initiates
the Draft, 1863*

Buy Your Way Out of Military Service

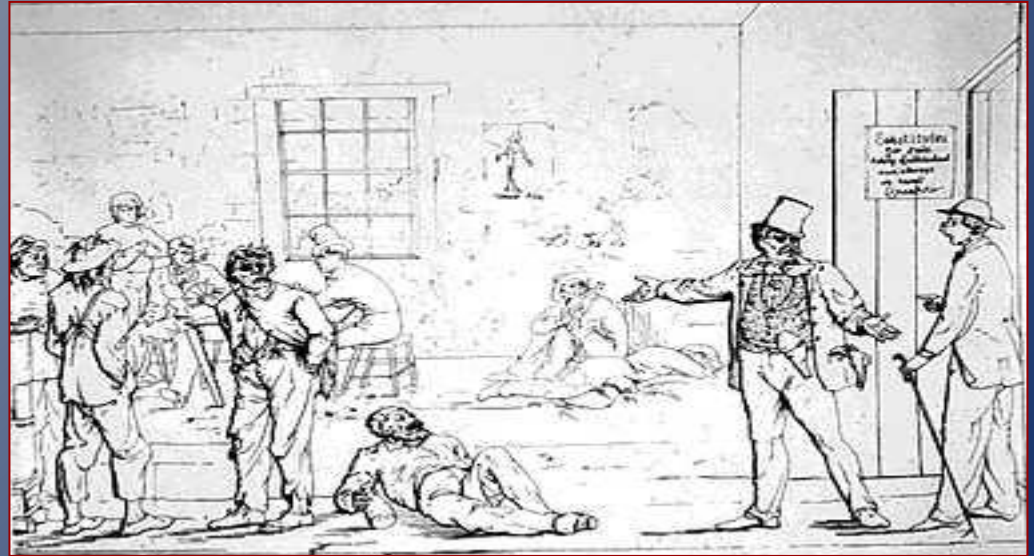
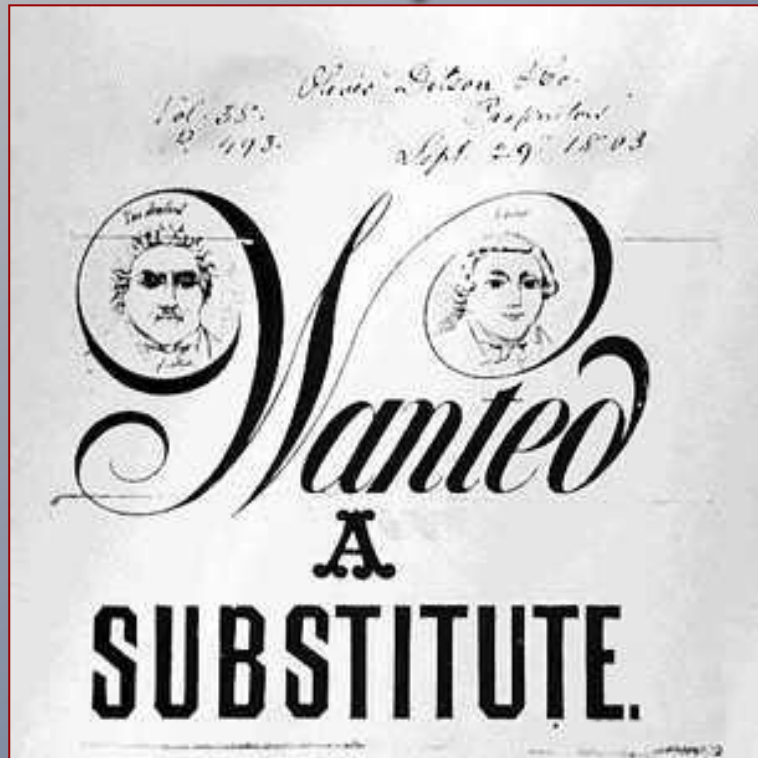

Division in the North

“Copperheads”

Opposed to continuing war

Oppose increased Federal power



THE COPPERHEAD PARTY.—IN FAVOR OF A VIGOROUS PROSECUTION OF PEACE!

ABRAHAM



AFRICANUS I.

His Secret Life,

AS REVEALED UNDER THE

MESMERIC INFLUENCE.

Mysteries of the White House..

J. F. FEEKS, PUBLISHER.

No. 26 ANN STREET, N. Y.

1864
Copperhead
Campaign
Poster

Cartoon Lampoons Democratic Copperheads in 1864



NYC Draft Riots, (July 13-16, 1863)

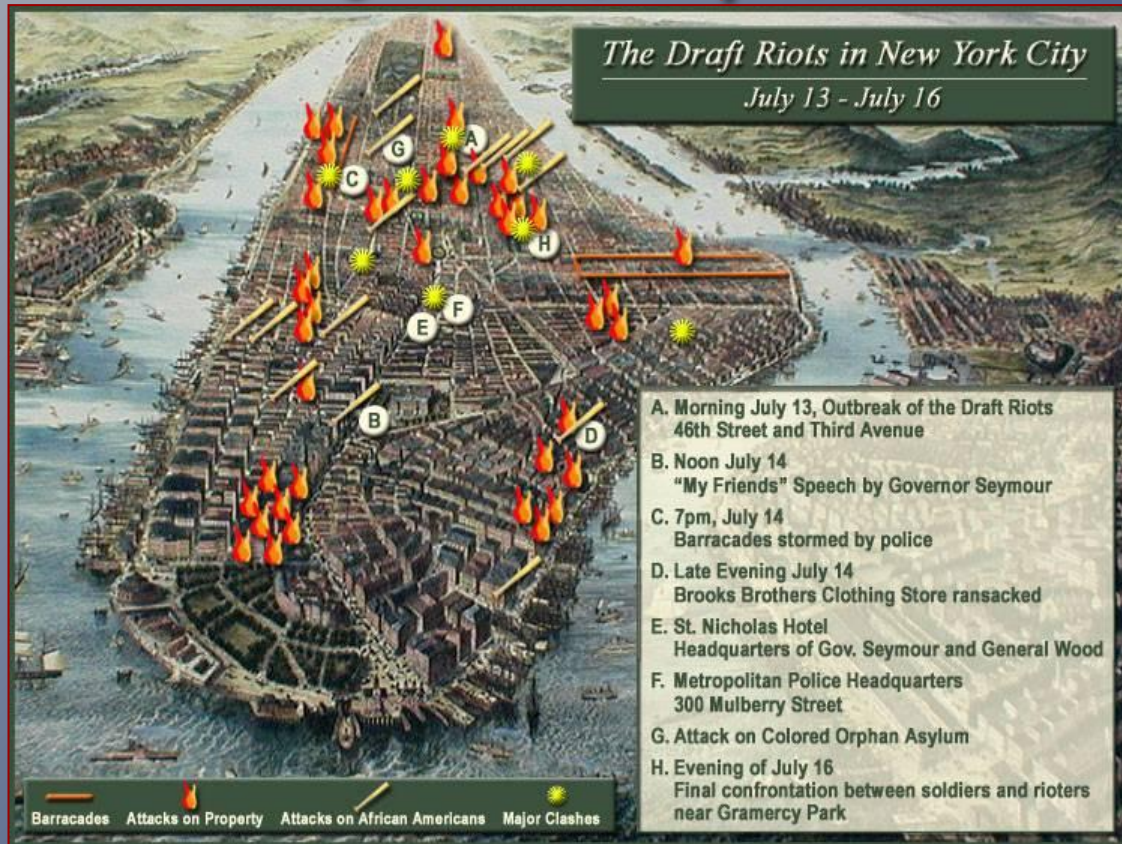

The Southern Economic Crisis

Union blockade

“King Cotton” Diplomacy

Inflation

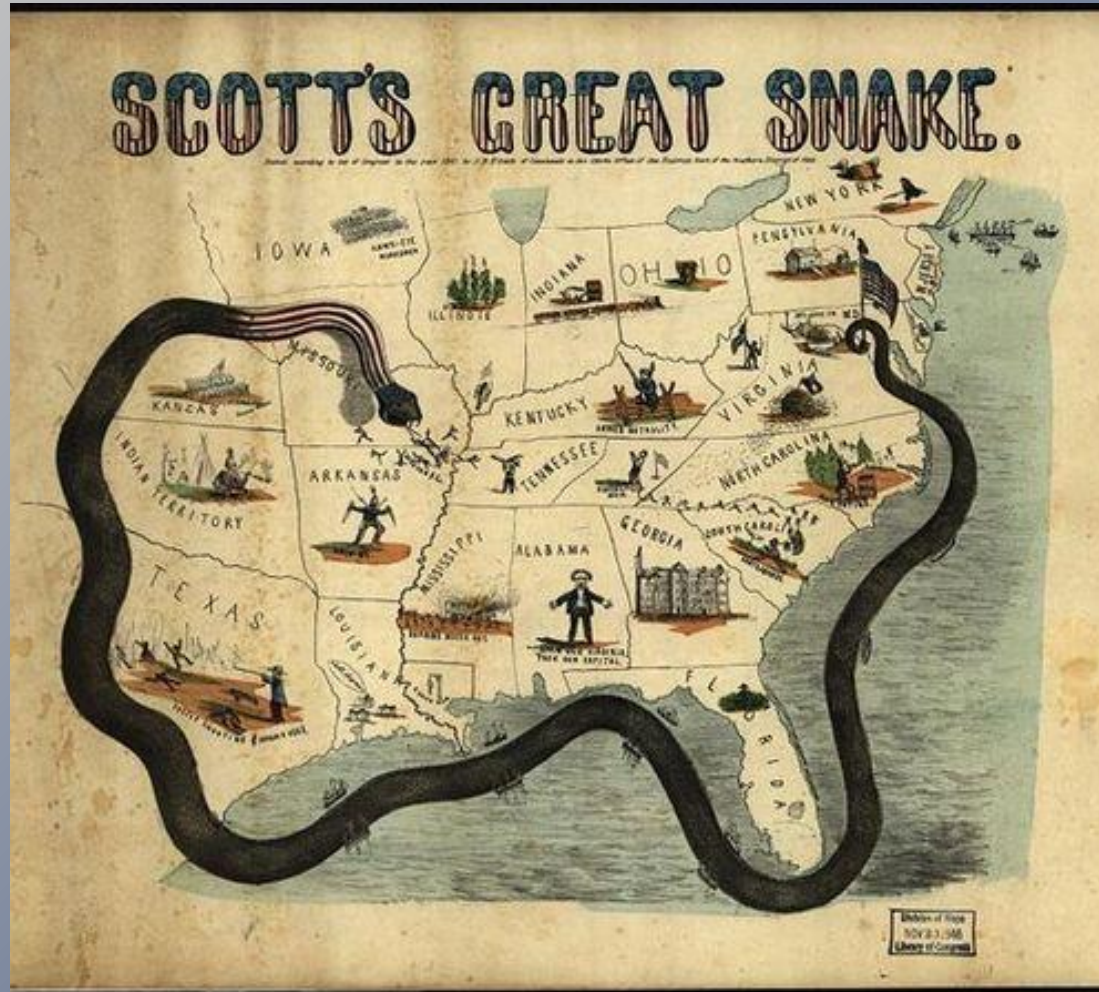

	1860	1863
Bacon, 10 lbs.	\$1.25	\$10.00
Flour, 30 lbs.	1.50	3.75
Sugar, 5 lbs.	.40	5.75
Coffee, 4 lbs.	.50	20.00
Tea (green), ½ lb.	.50	8.00
Lard, 4 lbs.	.50	4.00
Butter, 3 lbs.	.75	5.25
Meal, 1 pkg.	.25	1.00
Candles, 2 lbs.	.30	2.50
Soap, 5 lbs.	.50	5.50
Total	\$6.45	\$65.75

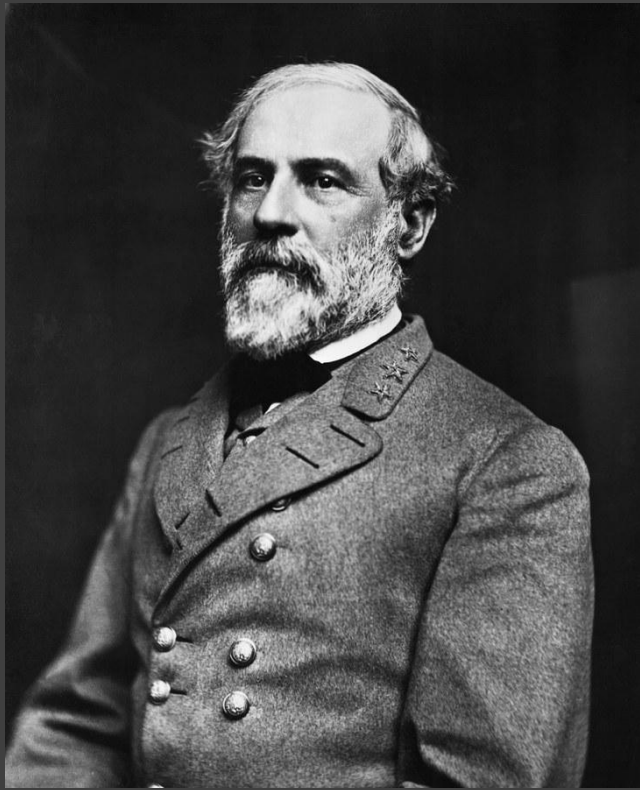

Robert E. Lee

1864

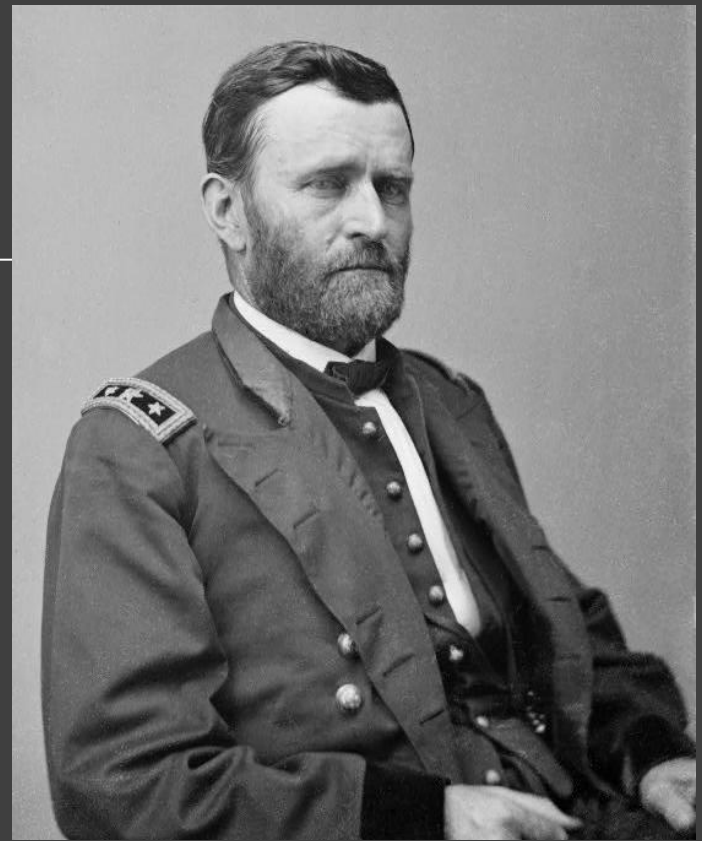

Ulysses S. Grant

Sherman's "March to the Sea" through Georgia, 1864

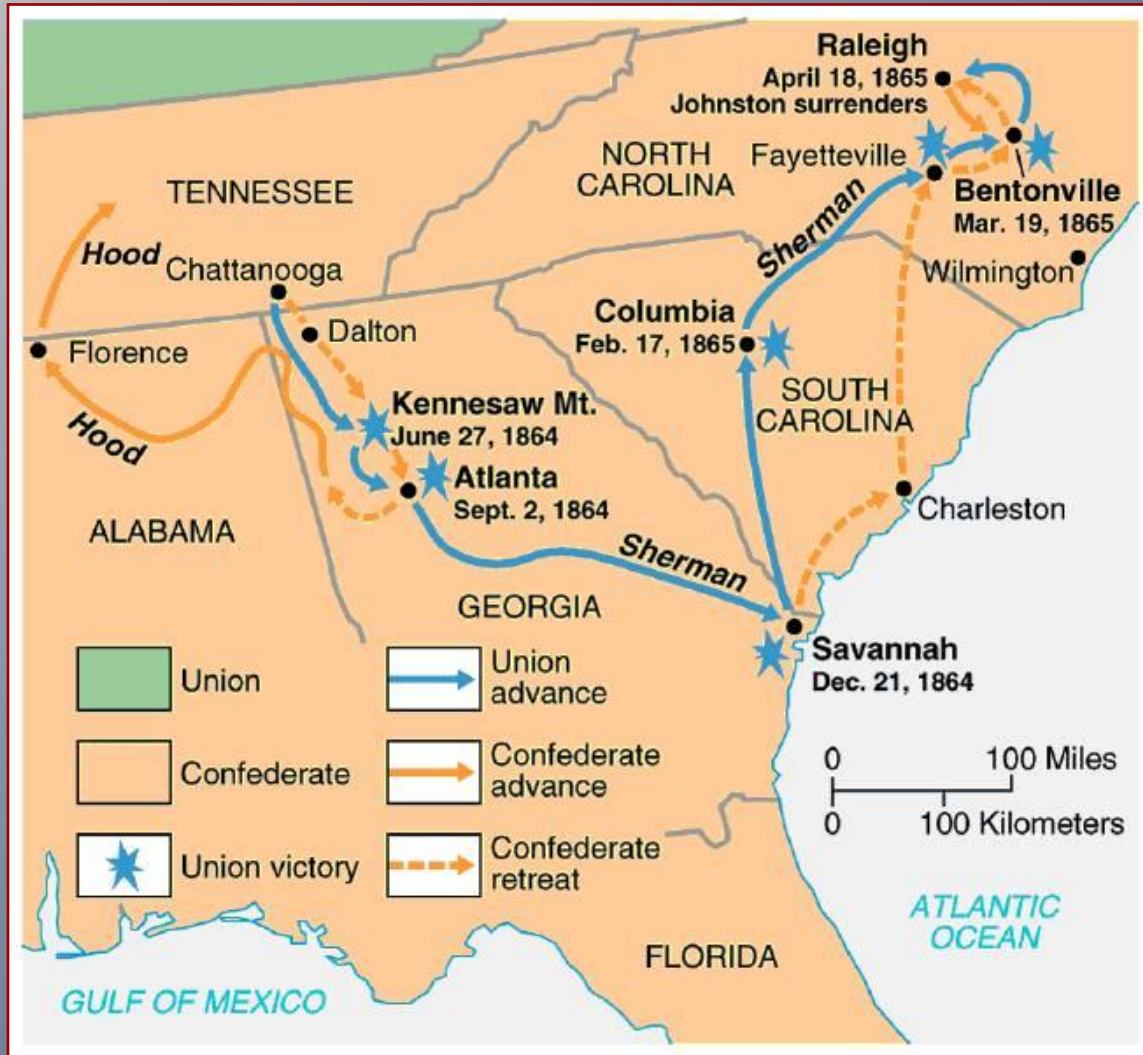



General William Tecumseh Sherman





Republican
Abraham Lincoln

Election of 1864

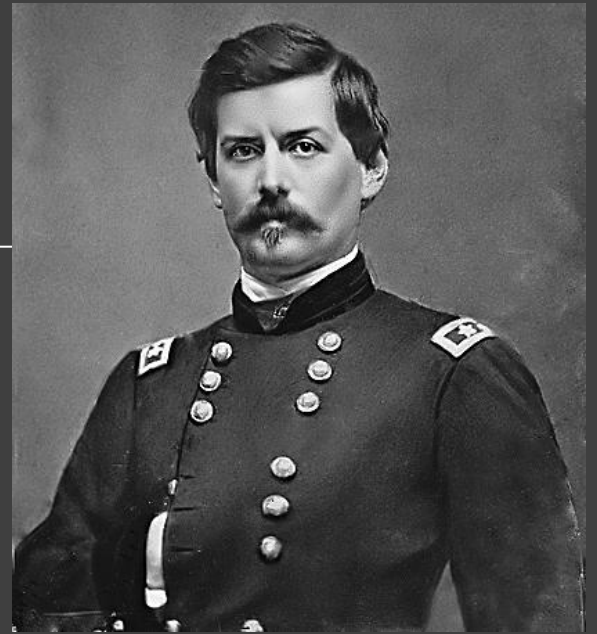

Democrat
George McClellan

Political Party	Presidential Nominee	VP Nominee	Electoral #	Popular #	%
Republican	Abraham Lincoln	Andrew Johnson	212	2,220,846	55.1
Democratic	George McClellan	George Pendleton	21	1,809,445	44.9



The Final Virginia Campaign: 1864-1865

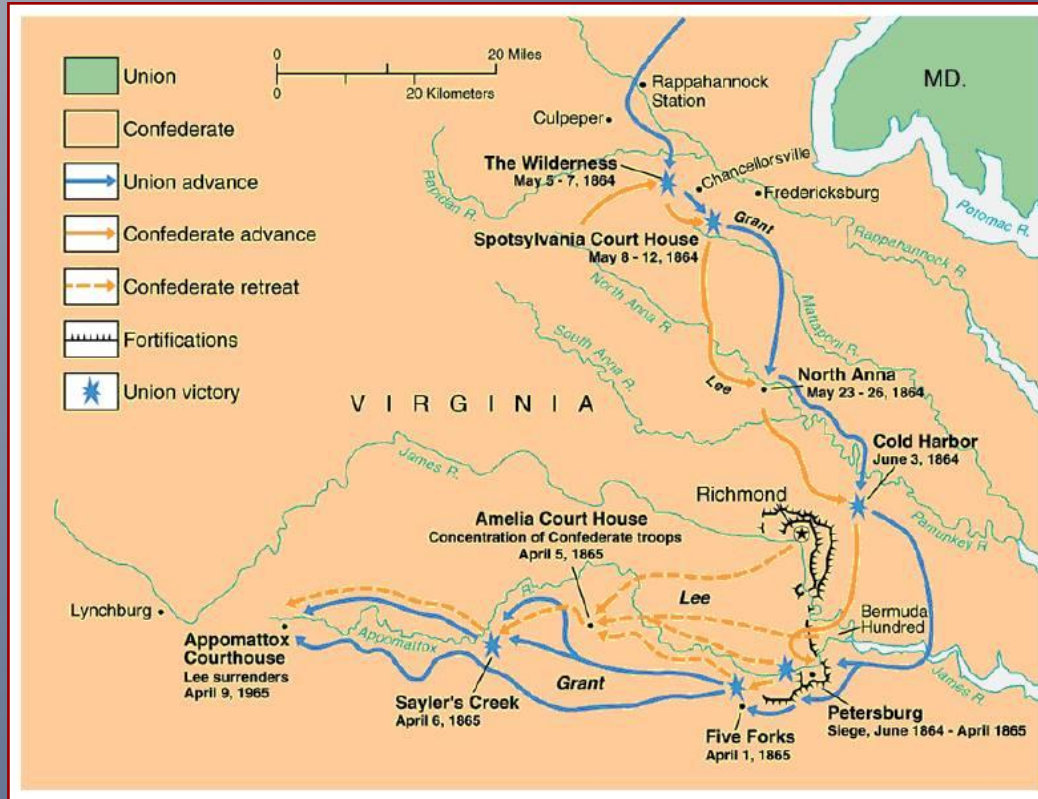

The Progress of War: 1861-1865



Surrender at Appomattox

April 9, 1865



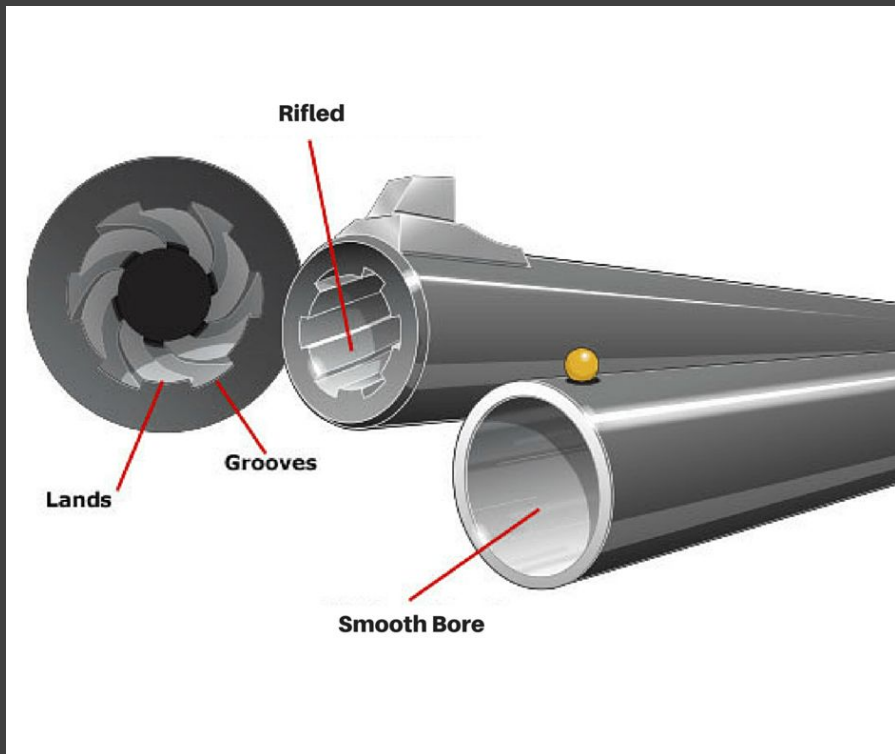

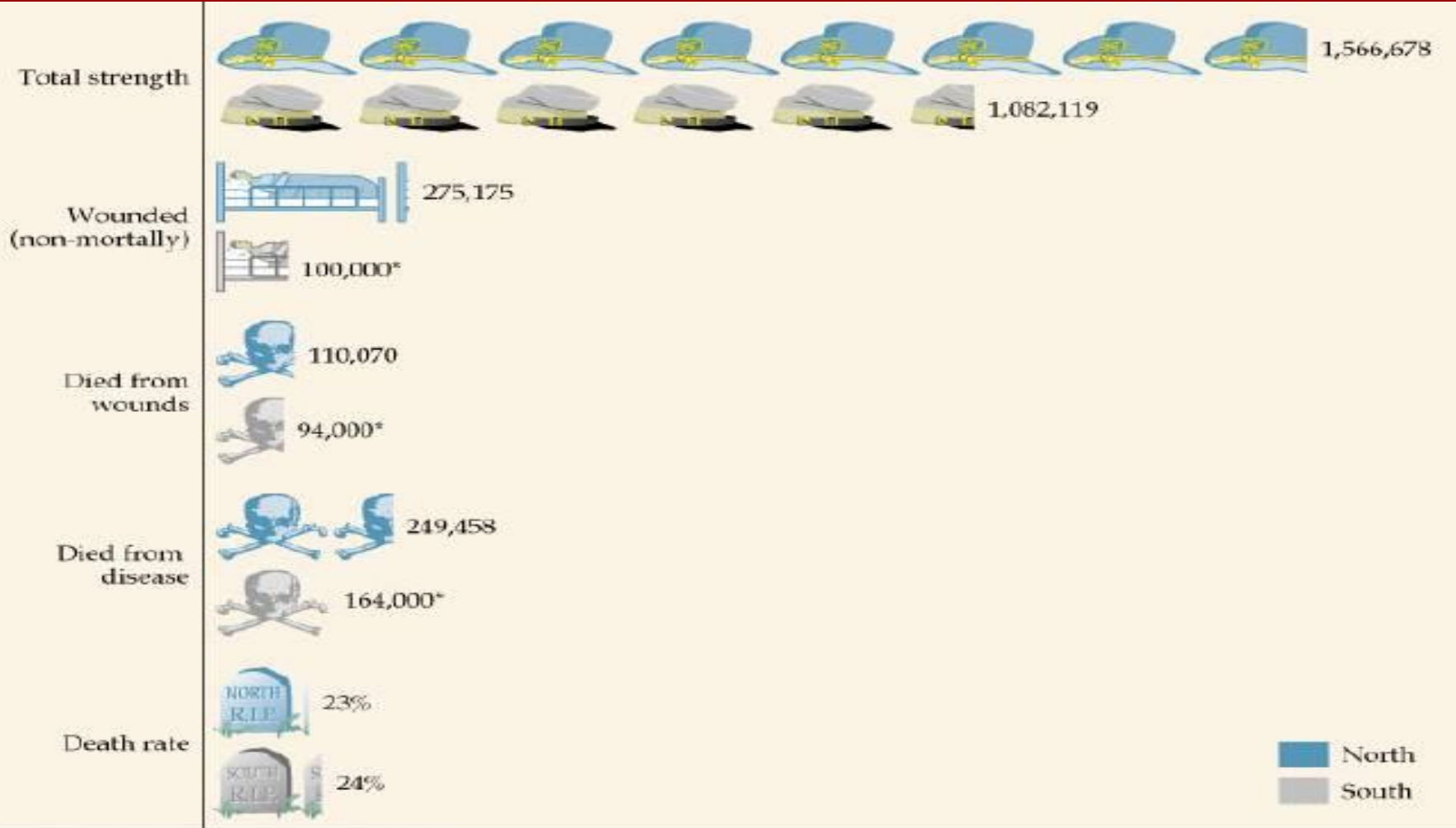

*Confederate figures represent accepted estimates.

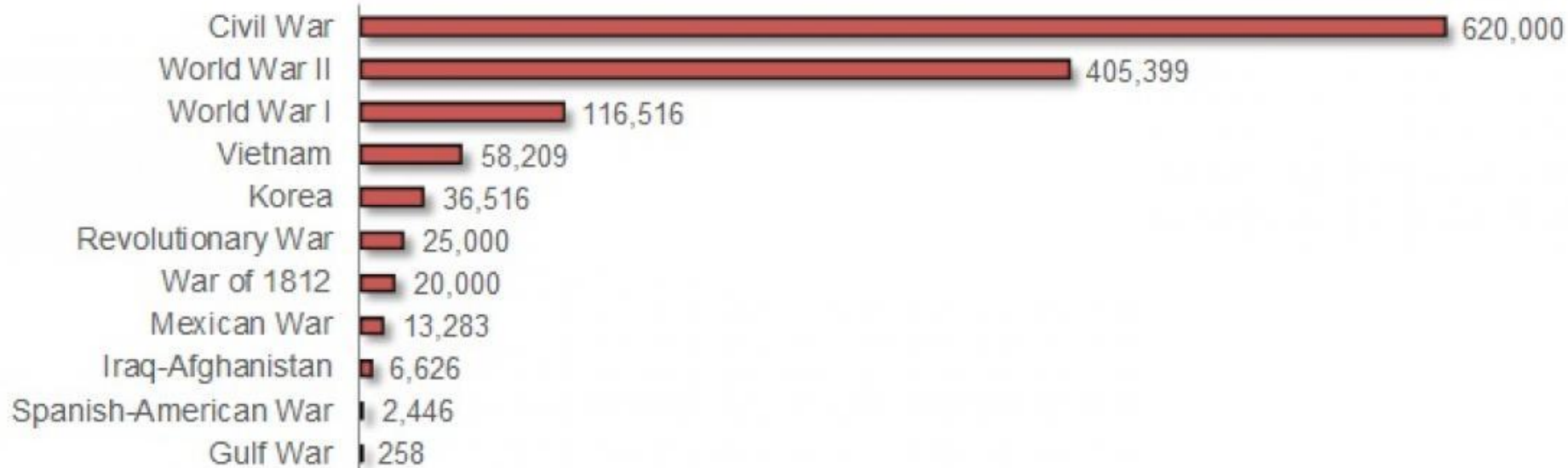

*The
Assassination
April 14,
1865*

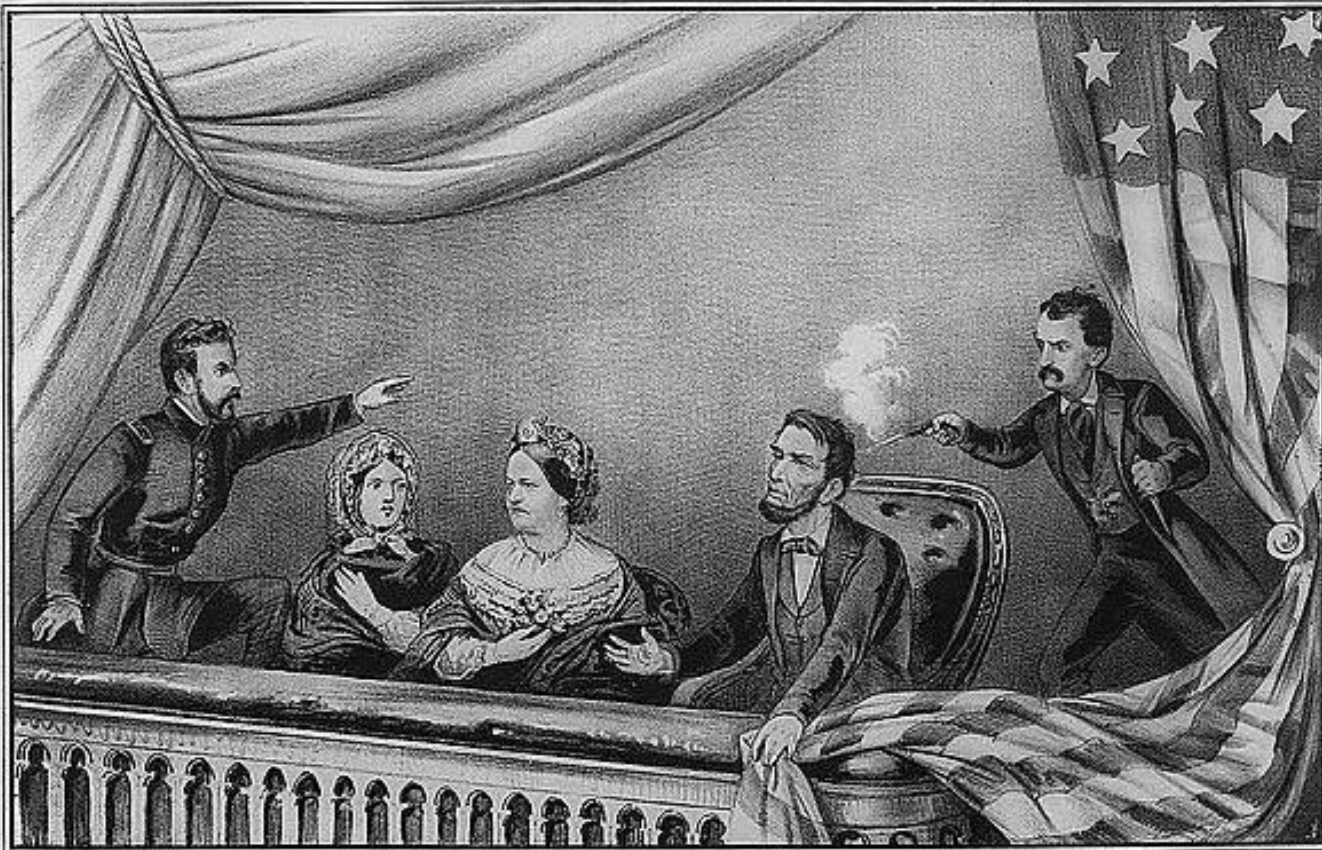

Major Rathbone.

Miss Harris.

Mrs. Lincoln.

President.

Assassin.

THE ASSASSINATION OF PRESIDENT LINCOLN

AT FORD'S THEATRE WASHINGTON, D.C. APRIL 14TH 1865.

Engraved by J. H. Johnson, New York. Published by Currier & Ives, 152 Nassau St. New York.

Published by Currier & Ives, 152 Nassau St. New York.